

# 80x80x32 mm (IP68)

50.3~59.4 CFM



■ Specification

Model	Bearing	Rated Voltage	Power Current	Power Consumption	Speed	Airflow	Static Pressure	Noise	Weight	Curve
	2BALL Sleeve	(VDC)	(mA)	(WATTS)	(RPM)	(CFM)	(inch-H <sub>2</sub> O)	(dB(A))	(g)	
GF80321B1-0000-AE9	☉	12	310	3.72	4800	59.4	0.36	45.2	109.0	1
GF80321B2-0000-AE9	☉	12	230	2.76	4500	55.9	0.32	43.1	109.0	2
GF80321B3-0000-AE9	☉	12	190	2.28	4100	50.3	0.27	41.1	109.0	3

■ Function R Type : FE9 / F Type : GE9 / PWM : HE9, QE9, SE9

■ Air Flow-Static Pressure Characteristics

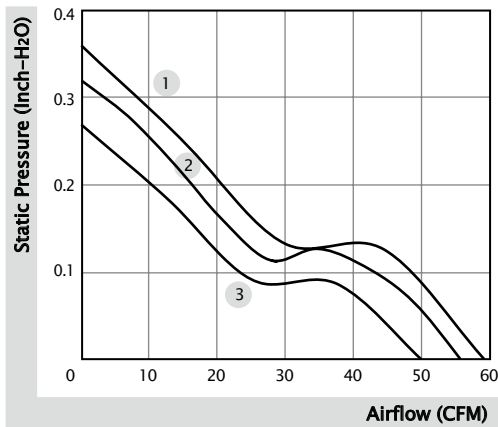

■ External dimensions(mm)

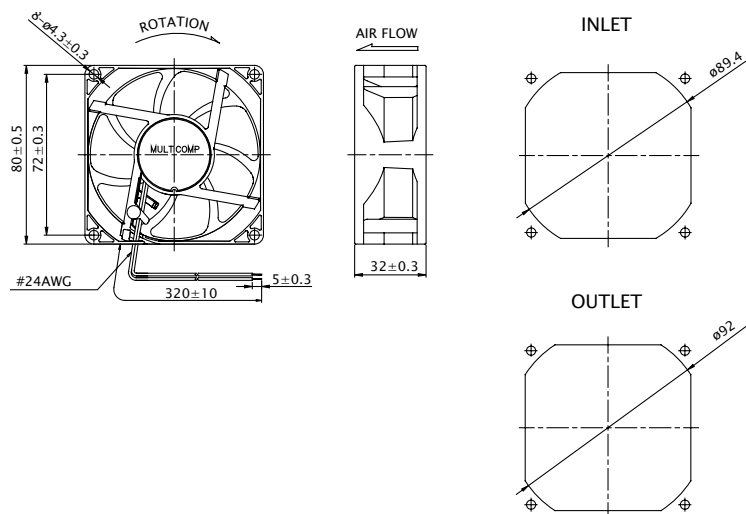

\* All model could be customized. Please contact with Sunon Sales.

\* Specifications are subject to change without notice. Please Visit SUNON website at [www.sunon.com](http://www.sunon.com) for update information.

■ RD / FG Output Signal

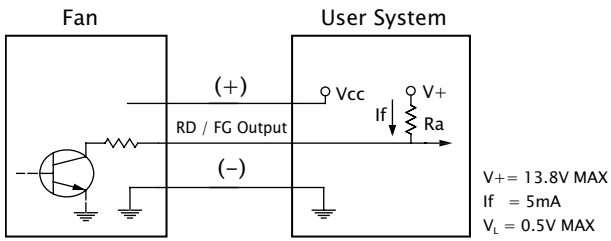

[ RD Signal ]

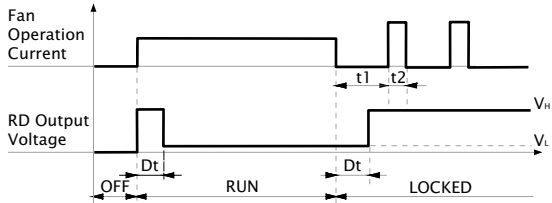

[ FG Signal ]

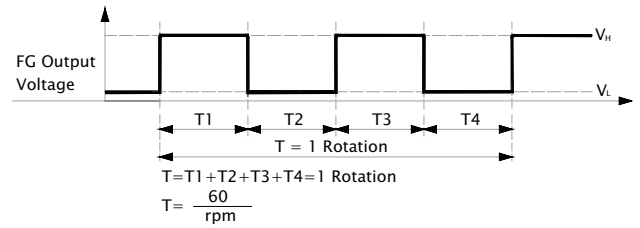

■ PWM Input Signal

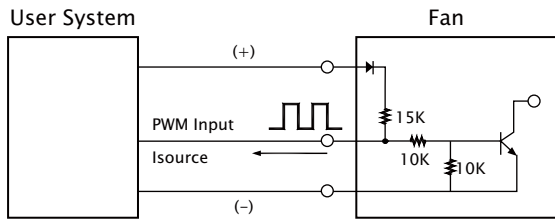

PWM FREQUENCY: 25KHZ  
 Isource=0..8mA at PWM Input Voltage 0V  
 The speed is default to be maximum if PWM input pin is unconnected.

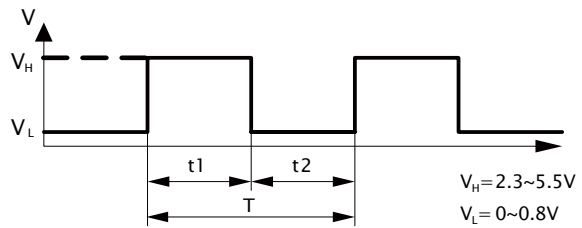

1. Period :  $T = \frac{1}{f_{PWM}} = T1 + T2(\text{sec})$

2. Duty Cycle (D.C.) :  $\frac{t1}{t1+t2} \times 100 = \frac{t1}{T} \times 100(\%)$

■ PWM Curve

